

# Nilo

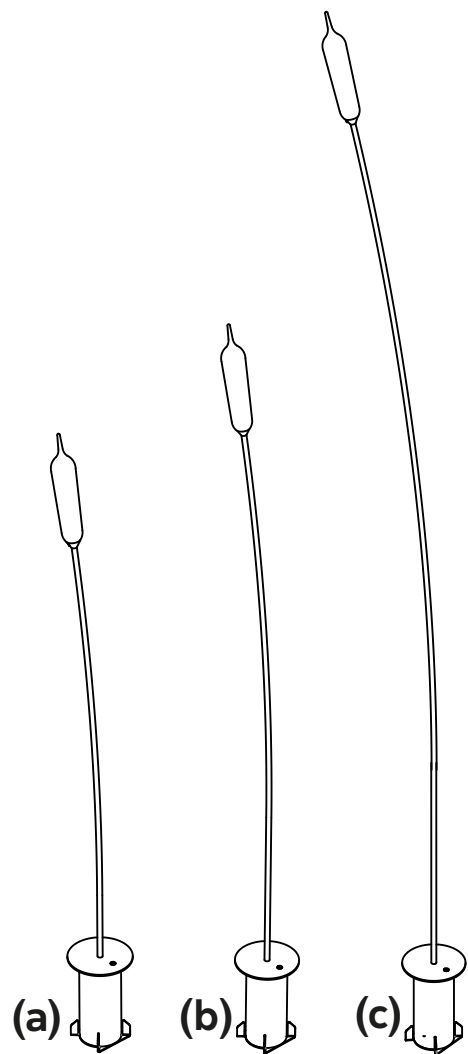

HP211 AN EXT (a)  
HP211 BN EXT (b)  
HP211 CN EXT (c)

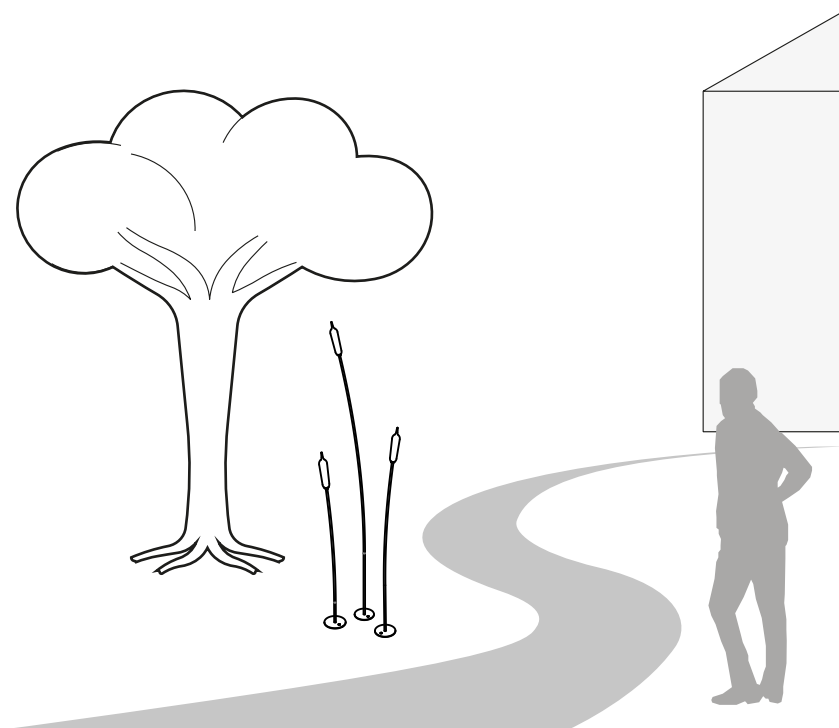

**Karman srl**

Via A. Grandi, San Martino del piano, 61034 Fossombrone (PU), Italy  
p.iva 02175640412 tel +39 0721 71 5042 r.a fax +39 0721 716640 - [www.karmanitalia.it](http://www.karmanitalia.it)

# KARMAN

350 mA  
led 3,2W

# IP65



# CE



# C - 01

---

V

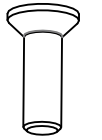

x2

---

T

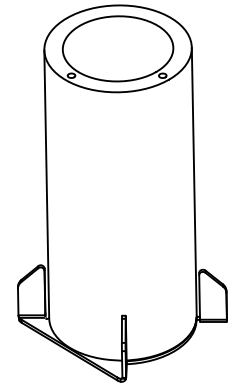

x1

---

B

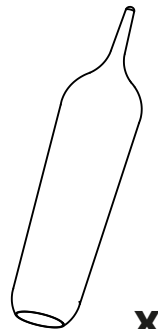

x1

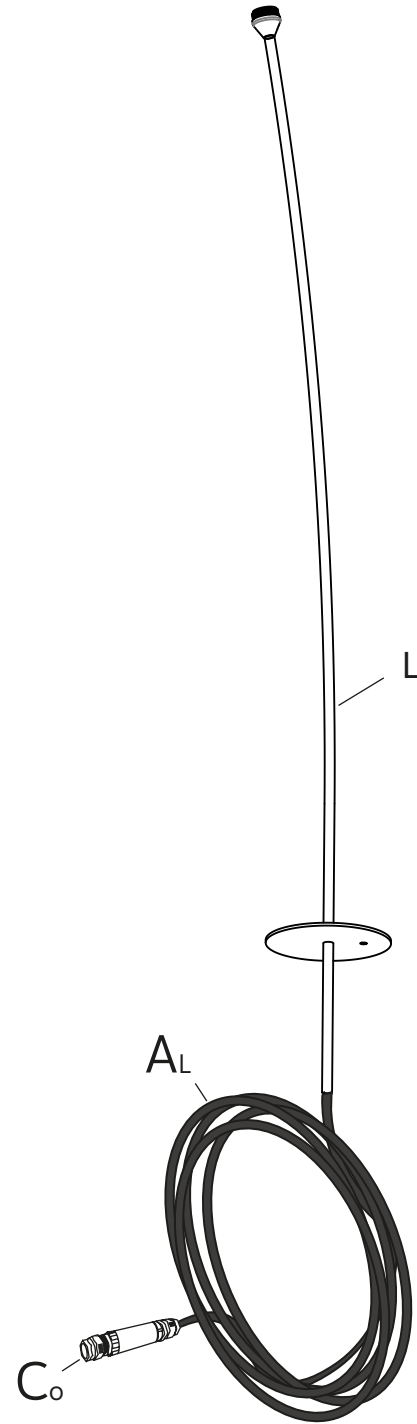

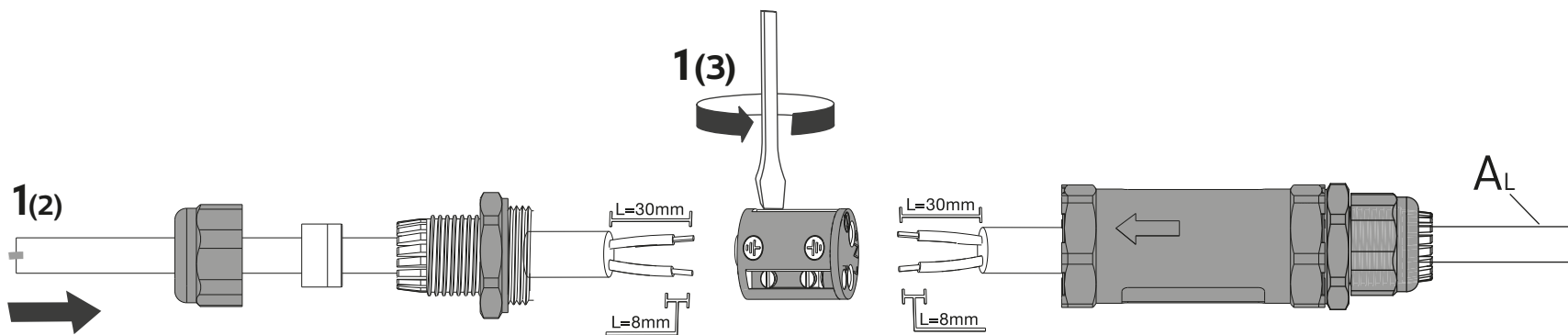
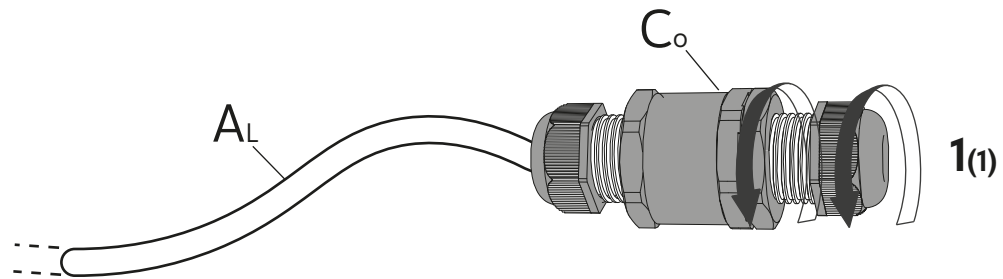
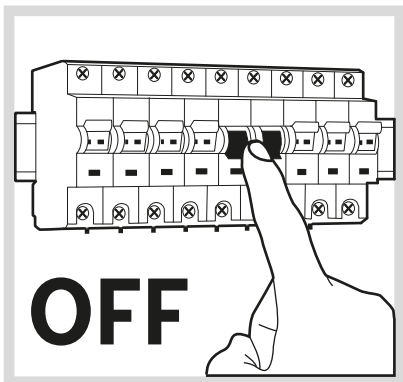

Constant current  
350 mA  
3,2W

